

SELECTUM

Klinker Quality with **Flexi**Lock





CERAMIC ROOF SOLUTIONS

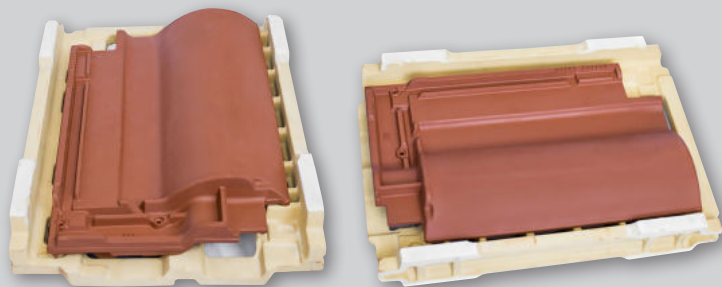

Single H fire supports that allow the tiles to be fired individually at high temperatures, obtaining perfect definition.



PERFECTION IS TO REACH THE TOP. La Escandella stands once again by the latest technology, heavily investing in a new production line designed to optimize the finish of its products and creating a Premium product range. Discover the new H-Selection line, made for excellence.

H-Selection is the result of applying modern manufacturing processes in H-Cassette to a selection of our products, endowing them with numerous functional and aesthetic advantages and benefits.



Excellent flatness

Individual curing of each tile thanks to support in H. Excellent flatness with no contact points.



High definition on each piece

It provides a perfect definition on each piece, made with gypsum moulds, providing a much finer texture.



Low absorption

Higher resistance to ice and mould formation.



Lifetime warranty

Our 100 years of warranty ensure your peace of mind and demonstrate the quality of our manufacturing process.

SELECTUM

Protection 4X

The most exposed area has 4 layers of protection.

Higher resistance

The clay composition together with the perfect pressing allows flexion higher than the required while only weighing 3,5 kg.

Lower absorption (<5%)

High quality clay together with high firing temperature mean higher resistance to ice and mildew.

High definition on each piece

The gypsum moulds provide a perfect finish, obtaining a smoother texture, no contact points nor creases.



Flexilock

A system to make the installation easier and guarantee a perfect fit for any roof. The number of tiles per square meter may vary from 11 to 14

Low pitch

Design optimized to be used in pitches as low as 19%/10°

Cost reduction

-30% weight vs. a concrete tile.
Lighter roof.
Cost-effective installation.

TECHNICAL CHARACTERISTICS

Flexural Strength test (EN 538)	Resistance > 1200N
Water Impermeability (EN 539-1)	Complies with level 1
Frost Resistance (EN 539-2)	Complies 150 cycles
Geometric Characteristics (EN 1024)	Flatness / Straightness $\leq 1,5\%$

Dimensions*	A: 468 mm; B: 280mm; C: 75 mm / A: 18.4"; B: 11"; C:3"
Pieces /sqm	11 - 14
Weight piece	3.500 gr / 7.71 lbs
Longitudinal fit **	348 - 383 mm / 13.7 - 15.07"
Transversal fit **	206 - 231 mm / 8.1 - 9.09"
Units per pallet	240 / 320
Weight pallet	840 kg / 1.120 kg // 1,852 lbs / 2,469 lbs
Laying	Straight bond

*The tile dimensions indicated in this chart allow a tolerance of approximately 7.2%
**Theoretic value; this should be re-calculated on site with the tiles that are to be used.

*Flexilock system offers vertical and lateral tolerance, which make the installation easier and guarantee a perfect fit for any roof. The number of tiles per square meter may vary from 11 (long. fit 383 and transv. fit 231) to 14 (long. fit 348 and transv. fit 206).

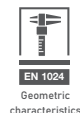



La Escandella
100 YEARS
GUARANTEE

PERFECTION AT THE
FOREFRONT OF DESIGN

Inspiring Colours

TSMK

BROWN KLINKER

TSRRK

RUSTIC RED KLINKER

TSRK

RED KLINKER

TSVK

GALIA KLINKER

TSPK

SLATE KLINKER

TSPRK

PROVENCE KLINKER

TIP

- Colour variations within one batch, affecting the whole of that batch and produced specifically for aesthetic reasons, are permissible.
- For tiles of one single colour, variations in color due to the ceramic process itself are accepted.
- We advise not to mix tiles from different batches on the same roof section.
- We recommend not to stack more than 2 pallets.

GLAZED RANGE

TSEG
CARMINE

TSEV
LIGHT GREEN

TSEO
DARK GREEN

TSEZ
LIGHT BLUE

TSEC
COGNAC

TSEN
BLACK

TSEA
DARK BLUE

TSECR
RUSTIC COGNAC



TECHNICAL ADVANTAGES

1 FLEXILOCK

- A system to make the installation easier and guarantee a perfect fit for any roof. The number of tiles per square meter may vary from 11 to 14.

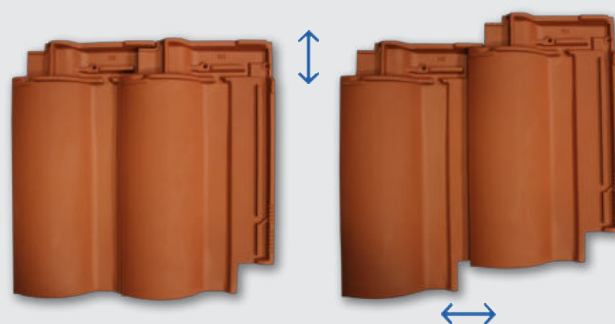

2 LOWER ABSORPTION

- Water absorption is lower than 5%.
- *Higher resistance to ice and mildew.*

3 PROTECTION 4X

- The most exposed area has 4 layers of protection.

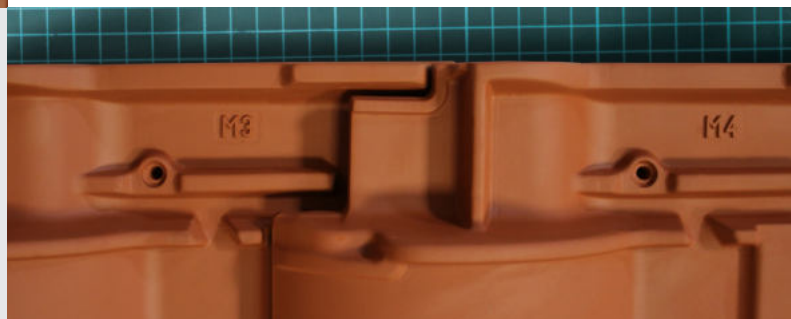

4 TOP INTERLOCKING

- Top interlocking sealed.
- *Bigger watertightness: tiles can be fixed straight on due to the interlocking system.*



5 NAIL HOLE

- Pre-hole (easy to be nailed)
- *Less tile breakages when nailing.*

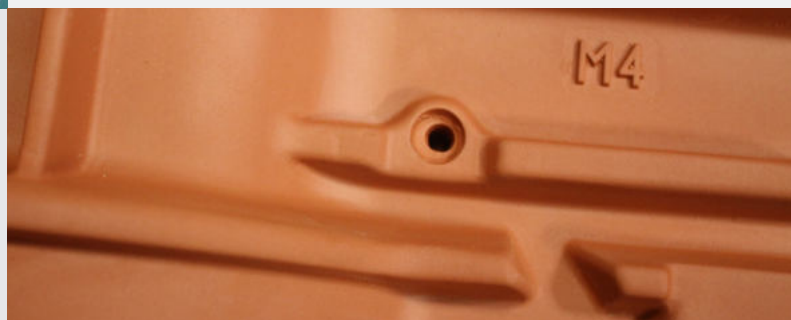

6 HOOK ATTACHMENT

- Sawtooth.
- *Easy hook fixing; one hook allows to fix 3 roof tiles at same time*





BEAUTY & FUNCIONALITY
ALL IN ONE



LAI D METHOD

1. The starter course will begin with the Selectum left side course (Q133K).
2. Start laying tiles structuring the eave from left to right and allowing a 5 cm (2") overhang at the eave.
3. The right section (vertical terminating end) will be finished with a Half (1/2) Tile (Q130K) over the Selectum right side course (Q134K).
4. Complete the installation with succeeding courses of tiles from the eave to the ridge.
5. Every 5 tiles it is recommended to draw a vertical control line to avoid deviations.

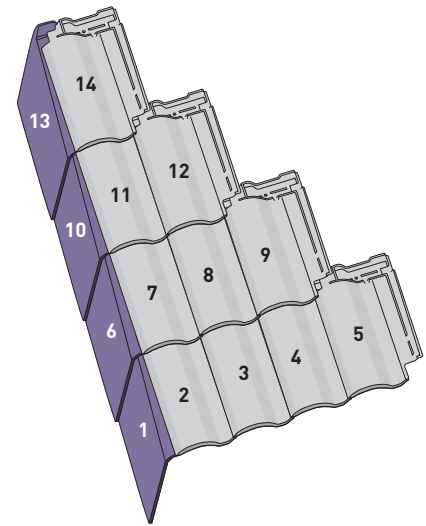

Selectum Half roof tile laying

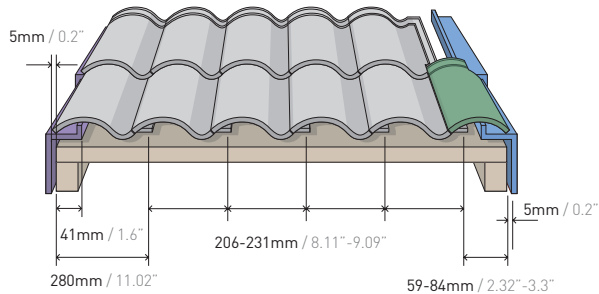

- Selectum roof tile
- Q133*K Selectum left side course klinker
- Q134*K Selectum right side course klinker
- Q130*K Selectum half roof tile klinker

Selectum Double roof tile laying

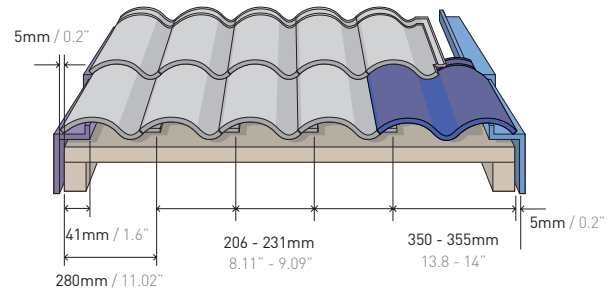

- Selectum roof tile
- Q133*K Selectum left side course klinker
- Q134*K Selectum right side course klinker
- Q138*K Selectum double roof tile klinker

TIP

Widthwise or lengthwise laid suggested in the technical catalogues are theoretical. The roofer must calculate the real widthwise or lengthwise laid of the tiles to be installed according to the methods defined in the rules in force in our installation manual.

Tiles are manufactured with natural components and fired at high temperature which generates small dimensional variations.

Download the
**INSTALLATION
MANUAL**



NOTE: A control line between 3 and 5 rows of tiles (maximum) is recommended.

First course batten should be 20 mm (3/4") higher than all succeeding course battens to provide a vertical alignment and to assure a symmetrical installation.

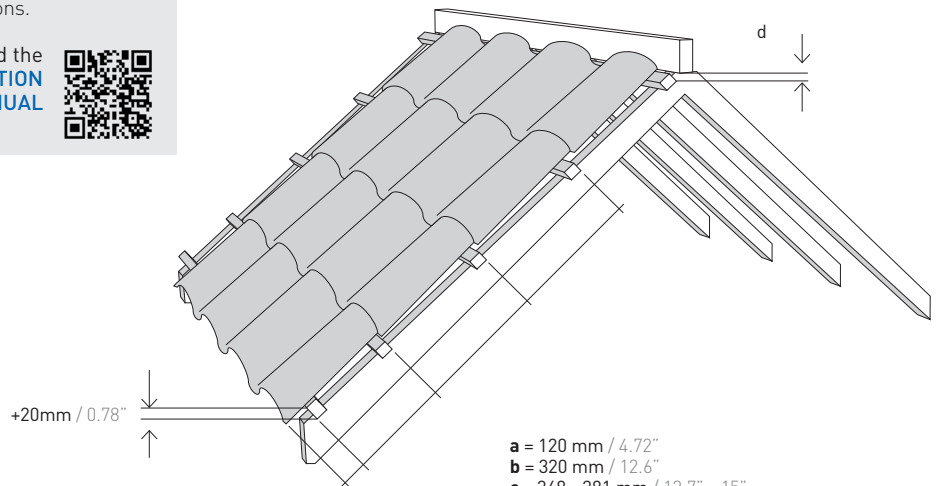

- a = 120 mm / 4.72"
- b = 320 mm / 12.6"
- c = 348 - 381 mm / 13.7" - 15"
- d = 0-20 mm / 0 - 0.78" (Depending on the slope)

INSTALLATION DETAILS

RIDGE

- Ridge tiles must be installed lap facing away from the prevailing winds, in order to assure water tightness.
- Field tiles at top course should be secured directly either into the deck or top batten with stainless ring screw nails or similar.
- At the top course of the roof (horizontal terminating end) field tiles can be finished by using Wedges (Q08K).
- All ridges and hips shall be covered with self adhesive Alu-Roll (CAM01, CAMF1, CAM09, CAMF9) or similar approved breathable waterproof underlayment. Underlayment should be secured over the ridge nailed with non-corrosive roofing nails.
- Apply ridge tiles with a minimum overlapping of 5 cm (2") throughout the ridge line facing away from the prevailing wind-driven rain.

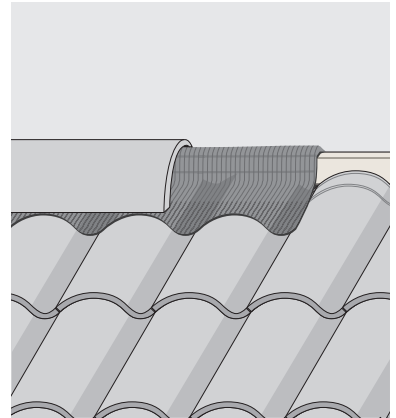

HIP

- Hip tiles must be installed in the same way as in the ridge.
- Field tiles must be miter cut parallel to the hip line and secured.
- All ridges and hips shall be covered with self adhesive Alu-Roll (CAM01, CAMF1, CAM09, CAMF9) or similar approved breathable waterproof underlayment.
- Air should be able to flow through the ridge and hip area. Be sure not to close these off with mortar or similar. Closing them off could result in cracks, peeling off., in freezing and thawing cycles.

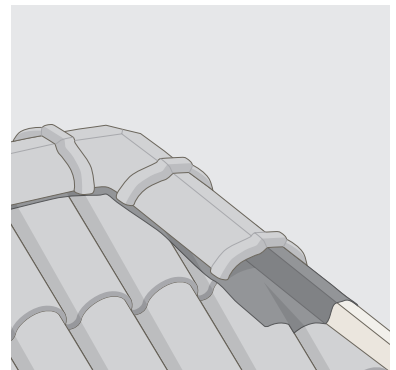

VALLEY

- Both Valley and eave line channel are particularly vulnerable to water migration and leakage. Valleys should have a clear and unobstructed pathway for quick water drainage.
- Install valley battens on each side of the valley crease. Alu-roll Valley (CAM18), or similar approved adhered waterproof valley underlayment, shall be laid vertically up all valleys in addition to other required underlayment that should be fixed by using glue, resin or similar.
- Where valley intersects with ridge line, apply Alu-roll Valley (CAM18), or similar approved underlayment, which should be covered by the ridge tile. Valley should be extended along the eaves to overhang the fascia board by 5cm (2") or over the gutter.
- Tiles should be laid parallel to the valley line, at same relative angle and should overhang the valley battens by at least 10 cm (4").
- Tiles at each side of the valley crease should be laid to provide a minimum 15 cm (6") width gap (tiles should held back minimum 7.5 cm (3") from the center of the valley each way).
- Valley tiles must be secured.
- Proper Valley flashing installation is required to ensure water tightness in order to avoid cracks, peeling off,...**

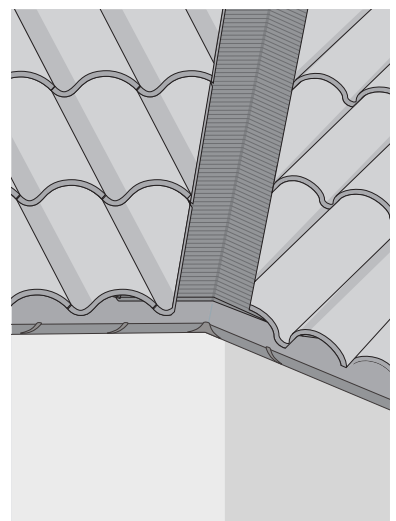

ACCESSORIES

Q01*K | Ridge / Hip klinker

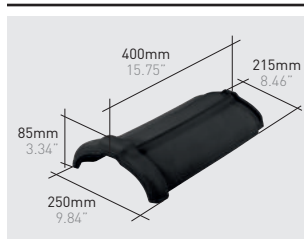

2,600 gr / 5.73 lbs 3 u./lm

Q03*K | Ridge end / Hip starter klinker

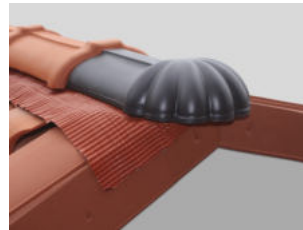

2,800 gr / 6.17 lbs

Q05*K | End cap / Straight gable end klinker

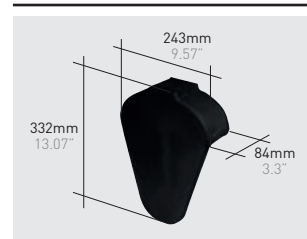

2,100 gr / 4.63 lbs

Q02*K | Round ridge / Hip klinker

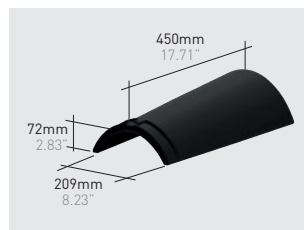

3,400 gr / 7.49 lbs 2.5 u./lm

Q04*K | Round ridge end / Hip starter klinker



3,300 gr / 7.28 lbs

Q83*K | End cap round ridge klinker

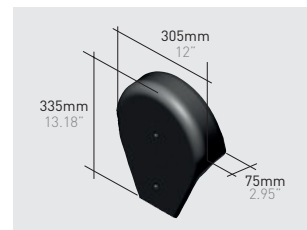

2,600 gr / 5.73 lbs

Q44*K | Round 3 way ridge klinker

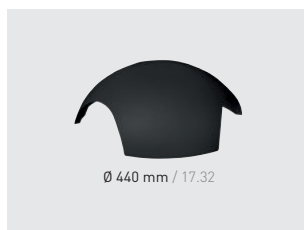

4,600 gr / 10.14 lbs with **Q02*K**

Q45*K | Round 4 way ridge klinker



4,100 gr / 9.04 lbs with **Q02*K**

Q55*K | Round 3 way ridge klinker (1 male-2 females)



4,100 gr / 9.04 lbs with **Q02*K**

Q08*K | Wedge klinker

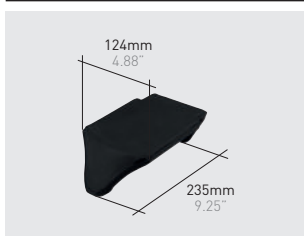

800 gr / 1.76 lbs

Q133*K | Selectum left side course klinker

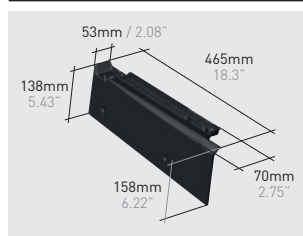

2.100 gr / 4.63 lbs 2,5 uds/ml

Q134*K | Selectum right side course klinker

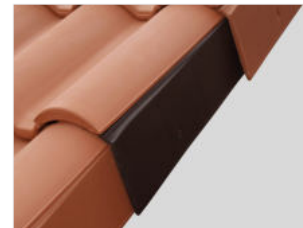
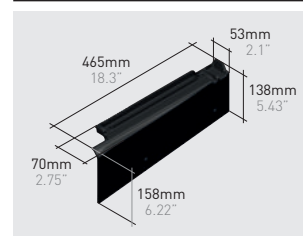

2.300 gr / 5.1 lbs 2,5 uds/ml

Q130*K | Selectum half roof tile klinker

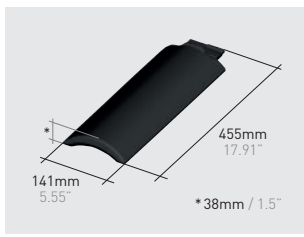

1.580 gr / 3.48 lbs

Q138*K | Double Selectum klinker roof tile

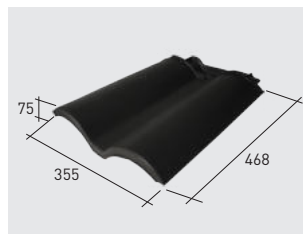

4.355 gr

Q131*K | Selectum ventilation roof tile klinker



3.500 gr / 7.71 lbs

Q132*K | Selectum chimney support klinker

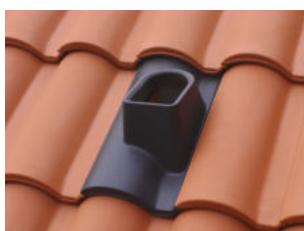
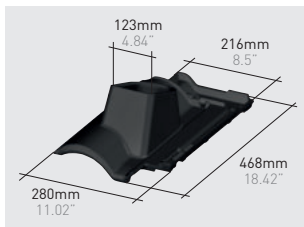

4.200 gr / 9.26 lb

Q135*K | Selectum chimney cover klinker

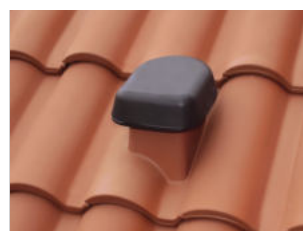
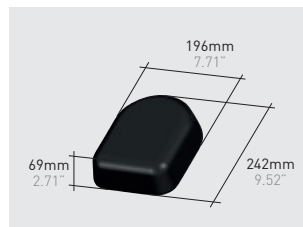

1.100 gr / 2.42 lbs with Q132*K

Q136*K | Selectum bird stopper klinker

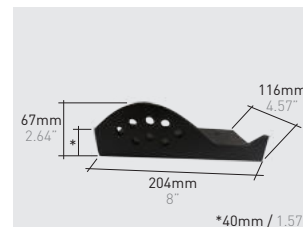

550 gr

ROOF ACCESSORIES FOR VENTILATED ROOFS

La Escandella offers a wide range of non-ceramic accessories which help finish off any type of roof. From waterproofing to ventilation, fixing and batten installing, safety implementation and multiple profiles can be found here. (Ask for wider range in last Price List).

CAM01 / CAMF1
Alu-Roll With Micro Cut



Width: Several sizes.
Colours: Red, brown, black.

CAM08 / CAMF8
Alu-Flex

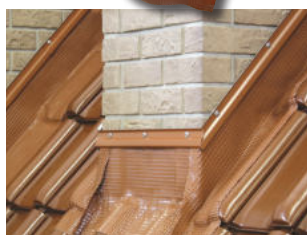
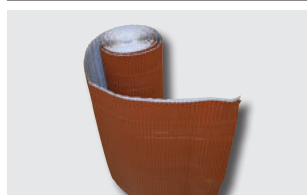

Width: Several sizes.
Colours: Red, brown, black.

CAM09 / CAMF9
Alu-Roll Membrane

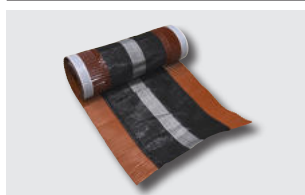

Width: Several sizes.
Colours: Red, brown, black.

CAM18
Alu-Valley Tape

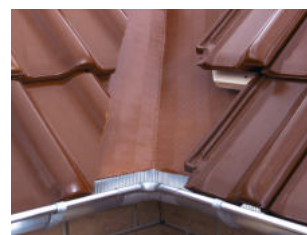
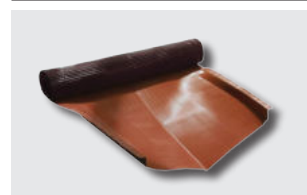

Width: 50 mm / 1.96"
Colours: Red, brown, black.

CAM65 / CAM21 / CAM52 / CAM53
Waterproof membrane



Dimensions: 1,5 m x 50 m / 1.64 yd x 54.68 yd
Weight: several weights.

CAM07 / CAM27NEW
Ridge Tile Hooks (Q01 / Q02)



Colours: Red, brown, black.

CAM05 / CAM10 / CAM51
Ridge Batten Brackets



Dimensions: Several sizes.

CAM16
Eaves Ventilation Comb



Dimensions: 6cm x 1m / 2.36" x 39.37"
Colours: Red, brown, black.

MORE INFO
ON THE
WEBSITE



CAM26
Universal clip for roof tiles with
lace



CAM62
Eave hook/clip for wooden
batten



TECHNICAL INFORMATION

SLOPES / PITCHES

The minimum pitch standard recommendations should always be followed (see values in the referral table). On all pitches below the standard recommended minimums, or in regions where ice dams may occur, a waterproof underlayment on the entire deck **MUST** be applied. Most problems with water-shedding roof installations occur from water that migrates through the joints of the tiles through capillary action, wind-driven rain, and runoff or ice damming. Because of this possibility, the underlayment is critical to the success of the roof.

	WITHOUT UNDERLAYMENT				WITH UNDERLAYMENT			
	ZONE 1	ZONE 2	ZONE 3		ZONE 1	ZONE 2	ZONE 3	
Protected	25% / 14°	27% / 15,5°	30% / 17°	Hip < 6,5 m	19% / 10°	21% / 11°	23% / 12°	Protected
Normal	25% / 14°	27% / 15,5°	30% / 17°		21% / 11°	23% / 12°	26% / 14°	Normal
Exposed	33% / 18,5°	37% / 20,5°	40% / 22°		28% / 15°	32% / 17°	34% / 18,8°	Exposed
Protected	28% / 16°	32% / 18°	36% / 20°	Hip 6,5 m - 9,5 m	22% / 12°	24% / 13°	26% / 14°	Protected
Normal	28% / 16°	32% / 18°	36% / 20°		24% / 13°	27% / 15°	31% / 17,5°	Normal
Exposed	35% / 19,5°	39% / 21,5°	43% / 23,5°		30% / 17°	33% / 18°	37% / 20,5°	Exposed
Protected	32% / 18°	35% / 19,5°	40% / 22°	Hip 9,5 m - 12 m	23% / 12°	26% / 14°	30% / 17°	Protected
Normal	32% / 18°	35% / 19,5°	40% / 22°		27% / 15°	30% / 17°	34% / 18,8°	Normal
Exposed	42% / 23°	45% / 24,5°	50% / 26,5°		36% / 19°	39% / 21°	43% / 23,5°	Exposed

PROTECTED LOCATIONS: hollow area which is surrounded by hills that protect the hollow from the winds in all directions..

NORMAL LOCATIONS:: Flat area, plateau with minimal elevation changes.

EXPOSED LOCATIONS: Places open to strong winds, coastal areas (up to 5 km / 3 miles from the shoreline), islands or narrow peninsulas, estuaries or closed bays, narrow valleys, isolated mountains, mountain passes and earthquake zones.

Note: For hips MORE than 12m long [39.4'], a waterproof underlayment on the entire roof deck **MUST** be applied and the ventilation underneath must be reinforced (check with the manufacturer).

FIXATION

The slope of a roof determines the level of fixation of the tiles required. The fixation of the tiles may be necessary to prevent the sliding of the roof tiles or to prevent their lifting by the effect of the air. **In eaves, right and left side course, lines of ridge, valleys, encounters with vertical walls and other singular points, all the pieces will be fixed.** For all other parts, the level of fixation will depend on the pitch.

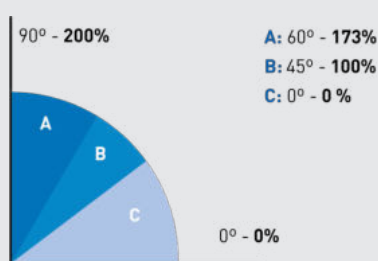

A: Every roof tile should be securely fastened by nailed, screwed, clipped...

B: Roof tiles will be fixed at least once every two or three, depending on the exposure of the roof and the height of the building.

C: The roof tiles shall be fixed at least in the proportion of one in five from a horizontal line, initiating fixation by rows alternately and regularly on the battens.

In case of high wind exposure, all roof tiles must be fixed.

VENTILATION

Ventilation is one of key elements to assure a good hygrothermal behavior of the roof and preservation of the roof structure. The key to a good and well preserved roof is a good ventilated roof. Proper installation of Ventilation tiles combined with ventilated roof can result in energy savings, in a more energy efficient home.

Air should be able to flow through the eave and ridge; be sure not to close these off with cement, mortar or similar. Eave and ridge areas should be protected to help minimize the access of birds and vermin infiltration.

A free flowing ventilation area must be provided through the roof deck. This ventilation should be evenly distributed throughout the roof space to eliminate any dead air space.

La Escandella recommends a minimum of ventilation tile (Q131K) for every 7 m² (1.32 vent tiles per 100 sq ft.) and with a minimum of 2 ventilation tiles per roof surface, installed on the upper part of the roof.

Using a proper ventilation system is the best way to avoid moisture in a roof, that could cause peeling, cracking and other defects on the tile.

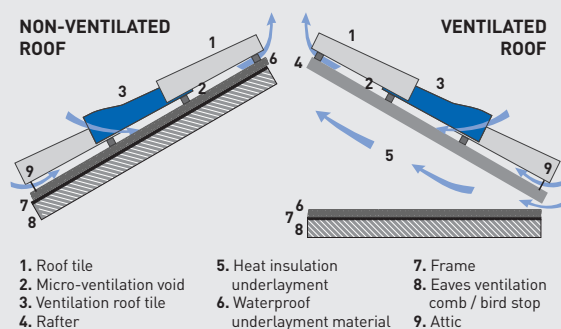



SELECTION
La Escandella



www.laescandella.com



Colour Shall be Harmonized but clay tiles are a natural product and some shade variations between individual pieces enhance their beauty and should be expected. All Tiles should be blended regardless of the number of colours supplied. Colours of the tiles shown in this catalogue can not faithfully reflect the colours of the ceramic tiles.

On their products, La Escandella has right to make changes in dimensions, fittings, weight & units per pallet, without previous notice. For more information, please contact your Sales Representative or our Customer Service.

This catalogue, printed in June 2023, replaces the existing ones.